

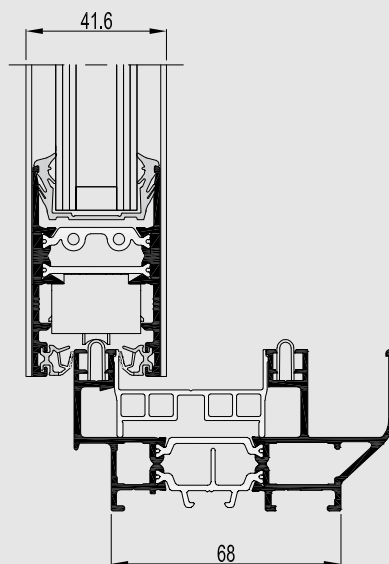

# CP 68

Elegance comfort and security

**R**  
REYNAERS  
aluminium

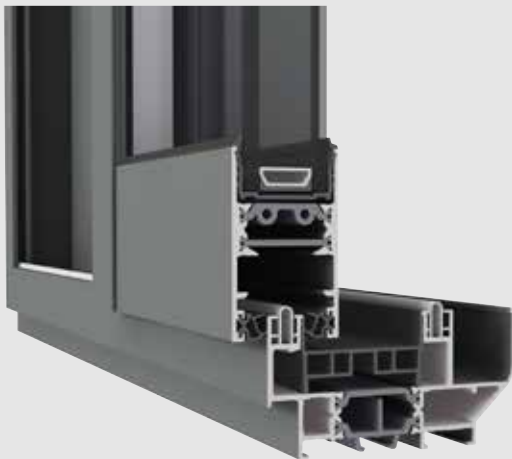

Concept Patio® 68 is a highly-insulated sliding system that combines elegance with performance and security. This unique sliding system is characterised by its slim profiles, allowing the integration of large windows and doors for maximum views, in combination with burglary resistance class RC2. The integrated innovative technologies guarantee ultimate performances with regard to wind and water tightness and thermal insulation, meeting with the highest standards.







The sliding system CP 68 offers you all design freedom to create contemporary living spaces, combining ultimate brightness with maximum comfort and security.



## FLEXIBILITY ABOVE ALL

This sliding system offers a wide range of opening possibilities, from elements which slide in a hidden wall cavity, over 2- and 3-rail solutions, allowing you to open up to 6 leaves.

TECHNICAL CHARACTERISTICS			
Variants		2-RAIL	3-RAIL
Visible width	Frame / Vent	109 mm	109 mm
	Meeting section	34 mm	34 mm
Overall system depth	Frame / Vent	68 mm	124 mm
	Meeting section	41.6 mm	41.6 mm
Maximal vent height		2500 mm	
Maximal vent weight		160 kg	
Rebate height		18 mm	
Glass thickness		28 / 36 mm	
Glazing method		with EPDM in accordance with the envelope principle	
Thermal insulation		32 mm and 36 mm fibreglass reinforced polyamide strips	

PERFORMANCES								
<b>ENERGY</b>								
	Thermal insulation <sup>(1)</sup> EN ISO 10077-2	Uf-value down to 2.51 W/m²K, depending on the frame/vent combination						
<b>COMFORT</b>								
	Acoustic performance <sup>(2)</sup> EN ISO 140-3; EN ISO 717-1	Rw (C; Ctr) = 38 (-2;-4) dB						
	Air tightness, max. test pressure <sup>(3)</sup> EN 12207	1 (150 Pa)	2 (300 Pa)	3 (600 Pa)	4 (600 Pa)			
	Water tightness <sup>(4)</sup> EN 12208	1B (0 Pa)	2B (50 Pa)	3B (100 Pa)	4B (150 Pa)	5B (200 Pa)	6B (250 Pa)	7B (300 Pa)
	Wind load resistance, max. test pressure <sup>(5)</sup> EN 12211; EN 12210	1 (400 Pa)	2 (800 Pa)	3 (1200 Pa)	4 (1600 Pa)	5 (2000 Pa)	Exxx (>2000 Pa)	
	Wind load resistance to frontal deflection EN 12211; EN 12210	A (≤1/150)		B (≤1/200)		C (≤1/300)		
<b>SAFETY</b>								
	Burglar Resistance <sup>(6)</sup> EN 1627-1630	RC1		RC2		RC3		

This table shows classes and values of performances, which can be achieved for specific configurations and opening types.

- (1) The Uf-value measures the heat flow. The lower the Uf-value, the better the thermal insulation of the frame.
- (2) The sound reduction index (Rw) measures the capacity of the sound reduction performance of the frame and glass.
- (3) The air tightness test measures the volume of air that would pass through a closed window at a certain air pressure.
- (4) The water tightness testing involves applying a uniform water spray at increasing air pressure until water penetrates the window.
- (5) The wind load resistance is a measure of the profile's structural strength and is tested by applying increasing levels of air pressure to simulate the wind force.
- (6) The burglar resistance is tested by static and dynamic loads, as well as by simulated attempts to break in using specified tools. This variant requires specific burglar resistance profiles and accessories.



REYNAERS ALUMINIUM NV/SA • t. +32 15 30 85 00 • www.reynaers.com • info@reynaers.com

11/2014 - OH0.30C2.00 - Publisher Responsible at Law: E. Fonteyne, Oude Liersebaan 266, B-2570 Duffel

